

DATASHEET- DIMENSIONS

HYDRAULIC CYLINDERS STANDARD 70/40-xxx

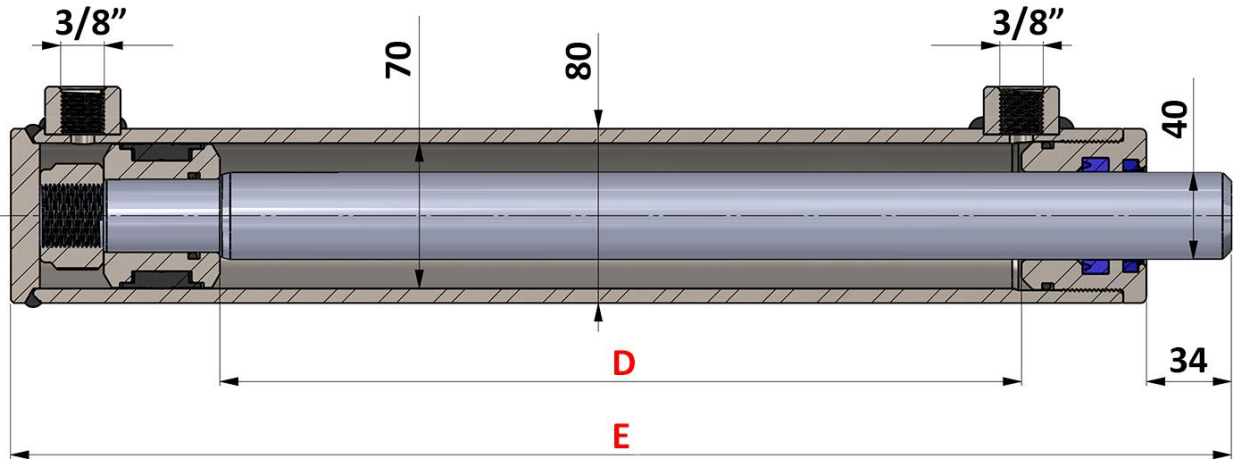

	STANDARD	E	D (stroke)
Code	70/40-xxx	[mm]	
12116	70/40-100	271	100
12117	70/40-150	321	150
12118	70/40-200	371	200
12119	70/40-250	421	250
12120	70/40-300	471	300
12121	70/40-350	521	350
12122	70/40-400	571	400
12123	70/40-450	621	450
12124	70/40-500	671	500
12125	70/40-550	721	550
12126	70/40-600	771	600
12127	70/40-700	871	700
12128	70/40-800	971	800
12129	70/40-900	1071	900
12130	70/40-1000	1171	1000
12131	70/40-1100	1271	1100
12132	70/40-1200	1371	1200
12133	70/40-1300	1471	1300
12134	70/40-1400	1571	1400
12135	70/40-1500	1671	1500
14837	70/40-1750	1921	1750
14838	70/40-2000	2171	2000